

OWNER'S MANUAL

AirGard[®] 335
Fume Hood Monitor



ALNOR[®]

TSI Incorporated

LIMITATION OF WARRANTY AND LIABILITY

Seller warrants that this product, under normal use and service as described in the operator's manual, shall be free from defects in workmanship and material for a period of twenty four (24) months, or the length of time specified in operator's manual, from the date of shipment to the customer. This limited warranty is subject to the following exclusions:

- a. Batteries and certain other components when indicated in specifications are warranted for a period of 90 days from the date of shipment to the customer.
- b. With respect to any repair services rendered, Seller warrants that the parts repaired or replaced will be free from defects in workmanship and material, under normal use, for a period of 90 days from the date of shipment to the customer.
- c. Seller does not provide any warranty on finished goods manufactured by others. Only the original manufacturer's warranty applies.
- d. Unless specifically authorized in a separate writing by Seller, Seller makes no warranty with respect to, and shall have no liability in connection with, any goods which are incorporated into other products or equipment by the Buyer. All goods returned under warranty shall be at the Buyer's risk of loss, Seller's factory prepaid, and will be returned at Seller's risk of loss, Buyer's factory prepaid.

The foregoing is IN LIEU OF all other warranties and is subject to the conditions and LIMITATIONS stated herein. NO OTHER EXPRESS OR IMPLIED WARRANTY OF FITNESS FOR PARTICULAR PURPOSE OR MERCHANTABILITY IS MADE.

THE EXCLUSIVE REMEDY OF THE USER OR PURCHASER, AND THE LIMIT OF THE LIABILITY OF SELLER FOR ANY AND ALL LOSSES, INJURIES, OR DAMAGES IN CONNECTION WITH THIS PRODUCT (INCLUDING CLAIMS BASED ON CONTRACT, NEGLIGENCE, STRICT LIABILITY, OTHER TORT, OR OTHERWISE) SHALL BE THE RETURN OF THE PRODUCT TO THE FACTORY OR DESIGNATED LOCATION AND THE REFUND OF THE PURCHASE PRICE, OR, AT THE OPTION OF SELLER, THE REPAIR OR REPLACEMENT OF THE PRODUCT. IN NO EVENT SHALL SELLER BE LIABLE FOR ANY SPECIAL, INCIDENTAL OR CONSEQUENTIAL DAMAGES. SELLER SHALL NOT BE RESPONSIBLE FOR INSTALLATION, DISMANTLING, REASSEMBLY OR REINSTALLATION COSTS OR CHARGES. NO ACTION, REGARDLESS OF FORM, MAY BE BROUGHT AGAINST THE SELLER MORE THAN ONE YEAR AFTER THE CAUSE OF ACTION HAS ACCRUED.

The purchaser and all users are deemed to have accepted the terms of this LIMITATION OF WARRANTY AND LIABILITY, which contains the complete and exclusive limited warranty of Seller. This LIMITATION OF WARRANTY AND LIABILITY may not be amended or modified nor may any of its terms be waived except by a writing signed by an authorized representative of Seller

Service Policy

Knowing that inoperative or defective instruments are as detrimental to Alnor as they are to our customers, our service policy is designed to give prompt attention to any problems. If any malfunction is discovered, please contact your nearest sales office or representative, or call Alnor's Customer Service department at (800) 424-7427 (USA) and (1) 651-490-2811 (International).

TABLE OF CONTENTS

Section 1	Introduction	
	General Description	3
	Component Identification	4
Section 2	Installation	
	Tools Required	7
	Mounting the Monitor	7
	Electrical Wiring.....	8
Section 3	Calibration	
	Overview	10
	Low Alarm Setup	14
Section 4	Normal Operation	
	Power Up Sequence.....	15
	Run Mode	15
	Monitor Test	16
	Horn.....	16
	Viewing Alarm Set Points	17
	Changing Alarm Set Points	17
	High Alarm Disable.....	18
	Emergency Purge.....	18
Section 5	Parameter Configuration	
	General	19
	Configuration Parameters	20
	CAL — Calibration	21
	P01 — Digits Enabled/Disabled	21
	P02 — Unit of Measure	21
	P03 — Temporary Horn Disable Timer.....	22
	P04 — Caution-to-Alarm Transition Delay Timer	23
	P05 — Alarm-to-Caution Transition Delay Timer	24
	P06 — Low Alarm Caution Offset	25
	P07 — Dis Input	26
	P08 — Alarm Input.....	28
	P09 — Relay Output 1.....	31
	P10 — Relay Output 2.....	33
	P11 — High Alarm Relay Disable.....	35
	P12 — Night Setback Low Alarm.....	36
	dEF — Reset Configuration Parameters to Factory Default Settings.....	37

Section 6	Troubleshooting and Service	
	Error Codes.....	38
	Troubleshooting Guide.....	39
	Service Requests.....	40
Section 7	Mounting Template.....	41

SECTION 1

Introduction

General Description

Air is drawn into a fume hood by an exhaust system that produces a differential pressure between the interior of the fume hood and the surrounding laboratory. The average velocity of the air moving perpendicular through the front sash opening of the hood is called the face velocity. Adequate face velocity is necessary to protect fume hood users by containing all of the contaminants inside the fume hood.

The AirGard[®] 335 continuously monitors fume hood face velocity by measuring the air velocity of clean air from the room passing through the air inlet on the front of the monitor. The monitor then reports this information via audio and visual indicators.

Visual Indicators — An electronic bargraph moves back and forth through universally recognized red (danger), yellow (caution) and green (safe) colored zones as the velocity changes. Corresponding large colored LEDs also illuminate. A digital display can be enabled to view velocity quantitatively.

Audible Indicator — A continuous audible alarm alerts of a dangerous situation when the face velocity is in an alarm condition.

Alarm information can be sent to other personnel in a remote location by means of a relay output.

IMPORTANT: *Fume hoods vary in design and performance. Because each hood installation and its air flow patterns is unique, the AirGard 335 Monitor must be calibrated in the field on the fume hood in which it is installed.*

Read this manual entirely before installing, calibrating, configuring, and using the AirGard[®] 335. If you need assistance or any further explanation regarding this instrument, please contact TSI.

Component Identification

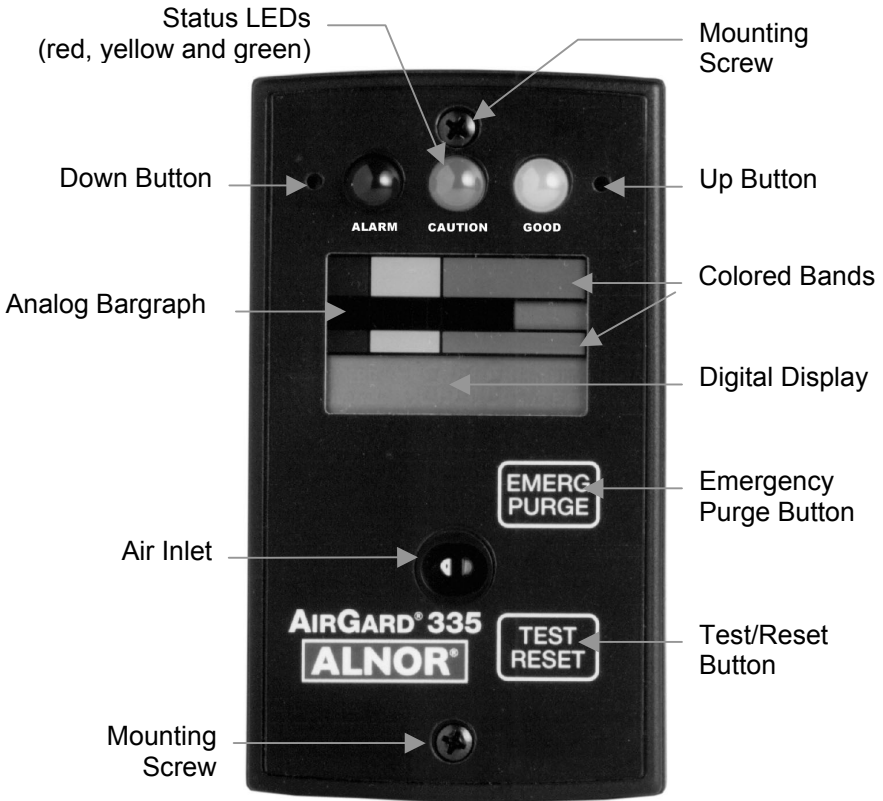

Figure 1 — Front View of Instrument

Status LEDs	<u>Red (Alarm)</u> — Indicates a high or low airflow alarm; <u>Yellow (Caution)</u> — Indicates that the airflow is within the caution zone between normal and low alarm; <u>Green (Good)</u> — Indicates that the airflow is within normal range.
Up Button	Up scroll button for configuration and calibration.
Down Button	Down scroll button for configuration and calibration.
Analog Bargraph	Electronic bargraph expands/contracts through colored zones as the flow velocity changes.
Colored Bands	Red, yellow and green colored bands on LCD glass correspond to alarm, caution, and normal zones.
Digital Display	Status indicators and icons reflect the status of monitor features. If digits are enabled, shows airflow velocity measurement either in feet per minute or meters per second.
Test/Reset Button	Tests the digital display, LEDs, audible alarm and relay output or, if an alarm is present, silences the audible alarm. It is also used during calibration and configuration.
Emergency Purge Button	When configured to operate, activates a relay that can be used to command the fume hood damper to open until pressed again.
Air Inlet	Guides room air to the sensor.
Mounting Screws	Two #6-20 screws secure the monitor to the fume hood.

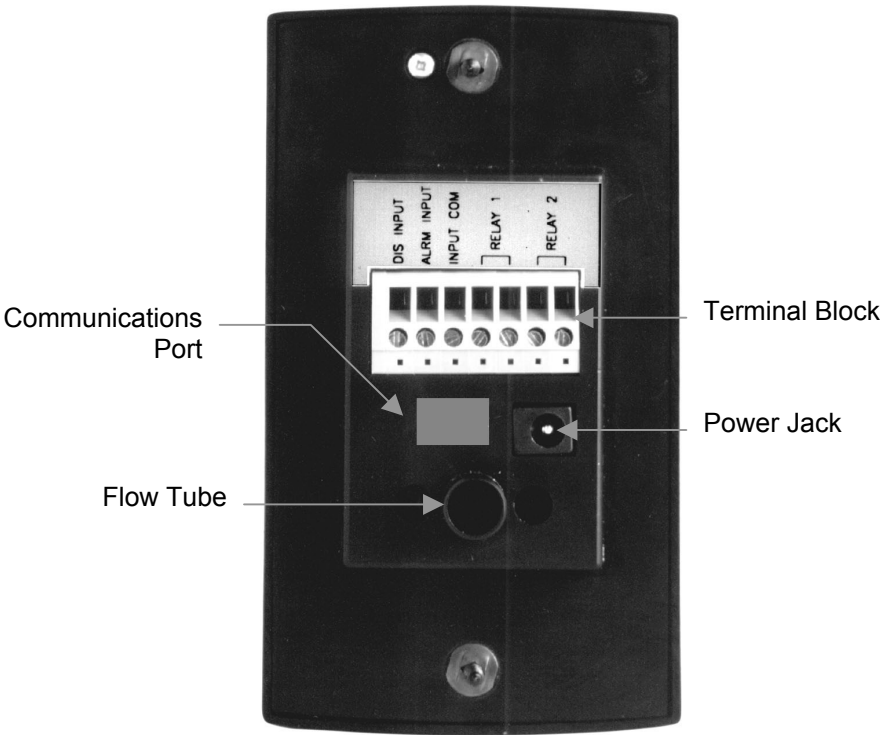

Figure 2—Back View of Instrument

Communications Port	For factory use only.
Flow Tube	Connects the flexible air hose attached to the fume hood side wall.
Terminal Block	Accepts 14-24 AWG wires. See the Installation section for wiring the monitor's various input/output features.
Power Jack	A suitable AC/DC power supply is supplied with US/Canada units; a 2.1 mm plug with 1.8 m power cord is provided for other countries.

SECTION 2

Installation

Tools Required

1. Power Drill
2. Drill bit size #37 (0.104 inch) (2.6 mm)
3. 9/16 inch (14 mm) diameter hole saw for cutting into side wall
4. Reciprocating saw with saw blades for cutting sheet metal
5. Pilot drill sized to fit saw blade
6. Phillips head screwdriver with #1 point
7. Small slotted screwdriver for securing wires to terminal block.

WARNING: If the monitor will be installed on a hood with Hardiboard™ fiber-cement panels or similar material, use a special hole saw designed for glass and other hard, abrasive materials. Failure to do so may shatter or crack the panel.

DANGER: Always wear eye protection when using power tools. Observe all necessary precautions when installing or repairing monitors near electrical equipment.

Mounting the Monitor

1. Determine where the monitor will be mounted. Use the cardboard template supplied as a guide for the size of the installed product and the hole needed to be cut out of the hood. The cutout required is 3 inches high by 2 inches wide (76.2 x 50.8 mm), which is the typical size required for a single switch electrical box. If the cardboard template is not available, a dimensioned diagram is at the back of this manual (see Section 7).
2. Using the template, mark off the 3 inch high by 2 inch wide (76.2 x 50.8 mm) hole necessary to clear the back enclosure portion of the monitor. Mark off the two mounting screw hole locations.
3. Drill a pilot hole in each of the four corners. Use the saw to cut out the hole. A suitable nibbling tool may also be used.
4. Drill the two #37 (0.104 inch) (2.6 mm) mounting screw holes.

-
5. Drill one 9/16 inch (14 mm) diameter hole in the side wall of the fume hood approximately 6 inches (152 mm) behind the sash and 1 inch (25.4 mm) above the sash bottom when it is at its true fully open position. Insert the side wall adapter from the inside of the hood and securely lock it in place from the back with the locking ring.
 6. Connect the input/output signal wiring, if required, to the terminal block on the back of the monitor. See the Electrical Wiring below.
 7. Connect one end of the supplied air hose to the side wall adapter. Route the hose as necessary to avoid kinks and bends which can affect proper air flow. Trim slightly if required. Firmly connect the other end to the flow tube on the back of the monitor.
 8. Connect the power cord to the power jack.
 9. Screw the monitor to the fume hood with the self-tapping screws provided.
 10. Plug the power supply into an appropriate electrical outlet.

Electrical Wiring

Power Jack — Power is supplied to the monitor through a power jack located on the back of the monitor. For units shipped within the United States and Canada, a suitable AC/DC power supply is supplied with the unit. Plug the power supply into 120 VAC nominal 60 Hz mains.

For monitors shipped outside the US/Canada, a 2.1 mm plug with a 1.8 m cord is provided. See the Specification section on the inside front cover for power requirements.

Terminal Block — The monitor has a seven-pin screw terminal block connector protruding from the back of the monitor. The terminal block accepts 14-24 AWG wires. These connections are for input/output features. See the Configuration Parameters section where indicated. The connections available are described below:

DIS INPUT: This allows you to activate the Test/Reset or Emergency Purge functions with a remote contact closure or remotely disable the monitor or change to a lower alarm setpoint during night setback. The night setback function may be wired to use open or closed contacts. When wired for “open” contacts, opening the contacts will disable the monitor; when wired for “closed” contacts, closing the contacts will disable the monitor. The connection should be made through a switch to the INPUT COM terminal. See Configuration Parameter P07.

ALRM INPUT (Alarm Input): This allows you to remotely activate the Test/Reset or Emergency Purge functions via a contact closure or wire an external alarm/event into the monitor. The external alarm function may be wired to use open or closed contacts. When wired for “open” contacts, opening the contacts will activate the monitor’s alarm; when wired for “closed” contacts, closing the contacts will activate the monitor’s alarm. The connection should be made through a switch to the INPUT COM terminal. See Configuration Parameter P08.

INPUT COM (Input Common): This is the ground used for the DIS INPUT and ALRM INPUT connections.

RELAY 1 (Relay 1): This relay has contacts that are open in the non-energized state. It can be configured to close for alarm, caution, or emergency purge or open for alarm, caution, emergency purge, or loss of power. See Configuration Parameter P09.

RELAY 2 (Relay 2): This relay has contacts that are closed in the non-energized state. It can be configured to open for alarm, caution, or emergency purge or close for alarm, caution, emergency purge, or loss of power. See Configuration Parameter P10.

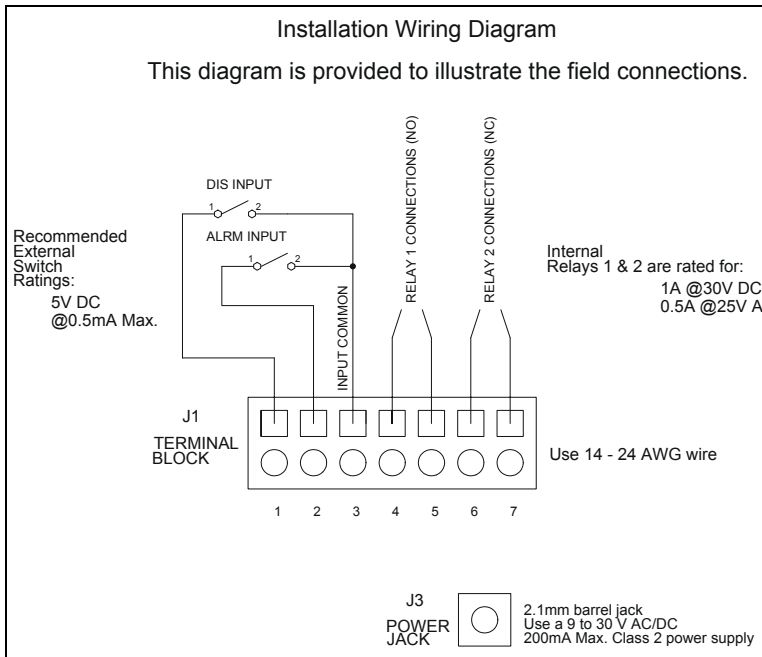

Figure 3 – Field Wiring Diagram

SECTION 3

Calibration

Overview

IMPORTANT: *Calibration procedures are for a constant volume hood. If you have a VAV hood, call TSI for the calibration procedure.*

The fume hood monitor must be calibrated before first use and checked annually thereafter. The calibration is stored in the non-volatile memory of the instrument and is not lost when the monitor loses power.

Fume hoods vary in design and performance. Because each hood installation and its air flow patterns is unique, this monitor must be calibrated in the field on the fume hood in which it is installed.

DANGER: Calibration and configuration of this monitor must be performed by qualified personnel. Proper guidelines for monitoring any ventilation apparatus are established on the basis of toxicity or hazards of the materials used, or the operation conducted within the ventilation apparatus. Personnel calibrating this monitor must be completely aware of the regulations and guidelines specific to its application.

If you need a reference on performing traverses on fume hoods, please consult ANSI/ASHRAE 110-1995 *Method of Testing Performance of Laboratory Fume Hoods*, section 6.2 Face Velocity Measurements.

Tools Required

1. Calibrated thermo-anemometer. Suggested instruments include the Model 9870 or Model 8570.
2. Small pointed tool to press the recessed Up and Down buttons. A straightened paper clip works well.

Procedure

1. Ensure that the monitor is properly installed. The flexible air hose should be attached securely to both the fume hood side wall and the back of the monitor.
2. The power supply plug should be firmly in the power jack on the back of the monitor and the power supply should be plugged into

an appropriate live electrical outlet. The monitor must be warmed up for at least 10 minutes to reach a stable operating temperature.

NOTE: *For the two point calibration, high and low face velocities need to be determined. These two values must be between 50 and 250 fpm (0.25 and 1.27 m/s). An accurate calibration requires that the low and high calibration points be separated by an adequate velocity. Therefore, a minimum separation value is set at the factory. After calibration is completed at the low point, the display will jump ahead to the suggested value for the high calibration point. Typical values for calibration are 70 fpm (0.36 m/s) for the low and 150 fpm (0.76 m/s) for the high.*

3. While the monitor warms up, use a calibrated thermo-anemometer to determine the velocity through the face of the hood by taking two detailed traverses. Take one traverse at low flow with the sash true full open (beyond the sash stop) and another at high flow with the sash at 12 inches (204 mm). For each traverse, divide the area under the sash into equal areas and measure at the center of those areas. Do not move more than 6 inches (152 mm) between readings. A minimum of sixteen readings must be taken per traverse. Record the average velocities and the sash heights where they are taken.
4. Move the sash back to the true full open position (i.e., the point where the low flow face velocity traverse was conducted).
5. Press and hold the Test/Reset button until you hear a double beep and see CAL displayed.

NOTE: *This Calibration initialization sequence takes approximately 10 seconds, during which the display will be fully lit (all segments on) for about 3 seconds and then blank (all segments off) for about 5 seconds before the word CAL appears.*

6. Press the Test/Reset button to begin the calibration process. Lo will be displayed for two seconds and then the low calibration reference starting point. Use the Up or Down buttons to adjust the displayed value to match the actual measured low face velocity (sash full open).
7. Press the Test/Reset button once the desired value is displayed and step away from the face of the fume hood. The monitor will count down 5 seconds (shown on the display) and then take readings for 20 seconds (again shown as a countdown display). This completes the Lo calibration; Hi will then be displayed for two seconds.

NOTE: *If an error message is displayed at this point, there is problem with the calibration and the procedure will be terminated. See Calibration Error Codes below.*

8. Move the sash to the 12 inch (305 mm) open position (the point where the high flow face velocity traverse was conducted).
9. Use the Up/Down buttons to adjust the displayed Hi value to match the actual measured high face velocity (sash at 12 inch/204 mm open position).
10. Press the Test/Reset button once the desired value is displayed and step away from the face of the fume hood. The monitor will count down 5 seconds (shown on the display) and then take readings for 20 seconds (again shown as a countdown display).
11. The monitor now conducts a self-test to determine if the calibration was successful. If this test indicates that the calibration was successful, the instrument will emit two quick beeps, store the new values in memory, and return the display to the CAL configuration menu selection.

This completes the calibration procedure. To view other parameter configuration menu selections (see Section 5), press the Up/Down buttons. To exit and return to the Run mode, press and hold the Test/Reset button for two seconds.

Calibration Error Codes

If an error occurs during a calibration step, the instrument will emit one long beep and the display will show an error code.



Error Code	Cause
ErL	Airflow below the instrument's measurement range.
ErH	Airflow above the instrument's measurement range.
Err	Too much variation in airflow.
Er2	Insufficient difference between the low and high calibration points.

If a calibration error is detected, the user must press the Test/Reset button to acknowledge the error condition. After acknowledgement, the monitor will return to the CAL configuration menu selection so that another calibration can be attempted. The incorrect values will not be stored in memory. The monitor will continue to use the previous calibration values until a correct calibration is successfully completed.

Suggestions For Obtaining An Acceptable Calibration

ErL — To obtain a slightly higher airflow velocity for the low cal point, lower the sash a few inches and take another set of velocity readings. Use this new sash position as the low cal position.

ErH — To obtain a slightly lower airflow velocity for the high cal point, raise the sash a few inches and take another set of velocity readings. Use this new sash position as the high cal position.

If the unit displays this error during Calibration, the thermistor is broken. Return to TSI for service.

Err — To get a more laminar (stable) set of sample readings, check the following during the 20 second calibration period:

- Make sure no one is walking in front of the hood.
- Make sure doors and windows are not being opened and closed.
- Do not change baffle positions on the hood.
- Check to see if the lab HVAC is cycling on or off, either heating or air conditioning.
- Compare all readings taken during the traverse to see if any vary by more than 10 fpm above or below the calculated average ('fast spots' or 'slow spots'). Hint: Set the thermoanemometer to the lowest possible time constant.
- Make sure the hose is connected properly to the sidewall of the hood and the monitor and is not kinked.
- Check for presence of a diffuser or supply grille right above the hood. If air is being "pushed" toward the front of the monitor, try diverting or blocking it.

Er2 — Adjust sash positions to achieve either a lower low cal point (by raising the sash) and/or a higher high cal point (by lowering the sash).

Low Alarm Setup

The low alarm setpoint should be established before first use and checked annually thereafter. The alarm setup is stored to nonvolatile memory and is not lost when the monitor loses power.

Procedure

1. Verify that the monitor was properly installed.
2. The power supply plug should be firmly in the power jack on the back of the monitor and the power supply should be plugged into an appropriate live electrical outlet. The monitor must be warmed up for at least 10 minutes to reach a stable operating temperature.
3. Once the monitor warms up, note the velocity displayed through the fume hood. This can be observed without changing the settings by pressing the Down Button and watching the number that alternates with the low alarm setting (the default setting is OFF).
4. Press and hold the Down Button for 5 seconds to access the low alarm setup menu. The current alarm setting will be displayed.
5. Use either the Up or Down Button to change the displayed value to match the actual desired low alarm point. Press the Test/Reset button when the desired value is displayed.

SECTION 4

Normal Operation

Power Up Sequence

On power up, the digital display is initialized and every segment of the display turned on for two seconds. All three of the LEDs and the horn are also activated.



After the two seconds has expired, the three LEDs and the horn will turn off. The version number of the firmware will then be displayed for two seconds.

Run Mode

An electronic bargraph travels horizontally through universally recognized red (danger), yellow (caution) and green (safe) colored zones as the flow velocity changes. Corresponding large colored LEDs also illuminate.

The green LED indicates a normal airflow condition. The yellow LED indicates that the airflow is within the caution zone between normal and low alarm. The red LED indicates an airflow alarm.

These Good, Caution, and Alarm zones are determined by a user programmed low alarm set point and set point offset. If the digits are enabled, the digital display shows the air flow velocity measurement either feet per minute (fpm) or meters per second (m/s). Over range measurements are shown as Hi. Under range measurements are shown as Lo.

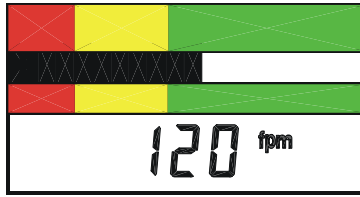

Monitor Test

During normal operation, pressing and holding the Test/Reset Button for 2 to 5 seconds will turn on all segments on the LCD and all LEDs as well as the horn and the alarm relay output. To test the emergency purge feature, press the Emergency Purge button; press it a second time to turn it off.

Horn

The horn will be activated whenever the Low or High Alarm zone has been reached (unless the horn has been permanently disabled).

Once the horn has been activated due to an alarm condition, it will stay on until the condition causing the alarm ceases to exist or the horn is temporarily or permanently disabled. If the horn is temporarily disabled, the horn will turn off and not come back on until either the temporary horn disable timer expires (Configuration Parameter P03) or another alarm condition is detected. If the horn is permanently disabled, the horn will not come back on until the horn is re-enabled.

The horn will sound when the sash override input is active and will remain on until the sash override input is deactivated or the Test/Reset button is pressed.

The horn will also sound when the Emergency Purge button is pressed and will remain on until the Emergency Purge button is pressed again or the Test/Reset button is pressed.

The horn will pulse intermittently when the external alarm input is active and will remain on until the external alarm input is deactivated.

If the night setback is active (with P12 set to "OFF"), the horn will be completely disabled in all instances until this input is deactivated. (See P07 for details)

Temporary Horn Disable

Pressing the Test/Reset button temporarily silences the horn. The horn slash through icon will be on the display indicating that the horn is temporarily disabled. If the horn is temporarily disabled, it will turn off and not come back on until either the temporary horn disable timer expires or until the monitor detects another alarm condition. See Configuration Parameter P03 for programming the timer.

Permanent Horn Disable

The horn may be permanently disabled during normal operation by pressing and holding the Test/Reset button for five seconds. After five seconds, the horn slash through icon will continuously flash on the display indicating that the horn is permanently disabled; the horn will no longer sound in an alarm zone or when any alarm input is activated. Removal of power to the monitor does not change this setting; upon restoration of power, the horn will still be disabled. The horn may be re-enabled by pressing the Test/Reset button for five seconds. The flashing horn slash through icon will then be shut off.

Viewing Alarm Set Points

The alarm set points may be viewed during normal operation by pressing the Up and Down Buttons. The Up Button is to the right of the green LED. The down button is to the left of the red LED. A straightened out paper clip works well to access them. If the Up Button is pressed, the display will toggle between the current reading and the High Alarm set point. If the Down Button is pressed, the display will toggle between the current reading and the Low Alarm set point.

The display will toggle between the current reading and the selected set point until there is no keypad activity for five seconds. At that point, the monitor will return to normal operation and display the current airflow reading.

Changing Alarm Set Points

The alarm set points can be changed during normal operation and while viewing a set point by holding the Up Button (High Alarm) or Down Button (Low Alarm) for five seconds. When the button is first pushed, the display will toggle between the current reading and the selected set point. If the button is held for five seconds, the monitor goes into a program mode that allows changing the selected set point. The corresponding LED will continuously flash and the display will turn on the PGM descriptor to indicate that the monitor is in program mode.

The displayed setting is changed by pressing the Up and Down Buttons. The Up Button will increment the set point by 1 fpm or by 0.01 m/s, depending on the units configuration. The Down Button will decrement the set point by 1 fpm or by 0.01 m/s. When the desired setting is displayed, press the Test/Reset Button. The PGM descriptor will flash once and the horn will give two quick beeps to acknowledge the save and the monitor will return to normal operation and display the current airflow reading.

IMPORTANT: *If the Test/Reset button is pressed and held for 2 seconds, the change will not be saved; this is signalled via one long horn beep*

LED Status When Changing the Alarm Setpoint

Alarm	LED Status
Low alarm	Red LED flashes
High alarm	Green LED flashes
Night setback low alarm	Yellow LED flashes

High Alarm Disable

The high alarm is enabled/disabled through the Changing Alarm Set Points procedure described above. To disable the high alarm, the high alarm set point should be set to OFF. While scrolling through the high alarm set point values, the OFF selection is located right after the upper most range of the allowable values. If the high alarm is enabled, the relay can be disabled/enabled for the high alarm by using Configuration Parameter P11.

Emergency Purge

This button can be configured to activate a relay that can be used to command the fume hood damper to full open until pressed again. See Configuration Parameter P09 and P10 to set up the relay.

SECTION 5

Parameter Configuration

General

NOTE: *Configurable parameters are stored to nonvolatile memory of the instrument and will not be lost when the monitor loses power.*

To access the Configuration mode, press and hold the Test/Reset button until you hear a double beep and see CAL displayed.

NOTE: *This Calibration initialization sequence takes approximately 10 seconds, during which the display will be fully lit (all segments on) for about 3 seconds and then blank (all segments off) for about 5 seconds before the word CAL appears.*

Once this mode is entered, the monitor will stop monitoring the airflow and display the configuration menu selections. The configuration menu selections are CAL, P01, P02, P03, P04, P05, P06, P07, P08, P09, P10, P11, P12 and dEF.

The first menu selection displayed is CAL. To view the other parameter configuration menu selections, successively press the Up and Down Buttons (Up to go forward; Down to go backward). When the desired configuration menu selection is displayed, press the Test/Reset button to enter. Within a selection, pressing the Up Button will scroll forward and pressing the Down Button will scroll backward. To quickly scroll, hold the button. The scrolling will wrap around when the allowable range is exceeded.

When a configuration menu selection is entered and a setting is changed, the Test/Reset button must be pressed to save the change. The PGM descriptor will flash once and the horn will give two quick beeps to acknowledge the save and the monitor will return to the Parameter Configuration menu.

IMPORTANT: *If the Test/Reset button is pressed and held for 2 seconds, the change will not be saved; this is signalled via one long horn beep.*

All parameters are configured in the same manner. To exit the Parameter Configuration menu, press and hold the Test/Reset button for 2 seconds. The monitor will also time out and exit the Parameter

Configuration menu after 1 minute has elapsed without any keypad activity.

SUMMARY: *Pressing the Test/Reset button for 10 seconds accesses the Configuration menu. Pressing the Up or Down Button advances to the next parameter and also navigates within a selection. Pressing once manually scrolls; holding scrolls quickly. Pressing and releasing the Test/Reset button after a change has been made saves it; pressing and holding the Test/Reset Button for two seconds cancels the change and exits.*

Configuration Parameters

The following table shows the factory default settings for the monitor's various programmable parameters. A default reset restores these settings.

Configuration Parameter	Factory Default
CAL — Calibration	(A field calibration is required. See the Section 3: Calibration)
P01 — Digits enabled/disabled	Disabled
P02 — Units of measure	English (feet/minute)
P03 — Temporary horn disable timer	255 (infinite)
P04 — Caution-to-alarm transition delay timer	3 seconds
P05 — Alarm-to-caution transition delay timer	3 seconds
P06 — Low alarm caution offset	20 fpm
P07 — Night setback input	CL.1 (night setback mode active with contact closure)
P08 — Alarm input	CL.2 (sash over-ride, activates with contact closure)
P09 — Relay output 1	CL.1 (alarm output, contacts close with alarm)
P10 — Relay output 2	OP.2 (alarm output, contacts open in alarm)
P11 — High alarm relay	OFF
P12 — Night setback low alarm	OFF
dEF — Default reset	Resets P01 – P12 parameters to factory defaults

CAL — Calibration

See Section 3 Calibration.

P01 — Digits Enabled/Disabled

The digits can be enabled or disabled using this Configuration Parameter. It only disables the numeric airflow velocity reading. The status indicators and icons will not be turned off. After this Configuration menu selection is entered, the monitor will turn on the program mode PGM descriptor and, if the digits are disabled, will show:

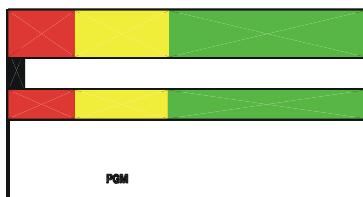

If the digits are enabled, one of the following will be displayed depending on the current unit of measure selected:

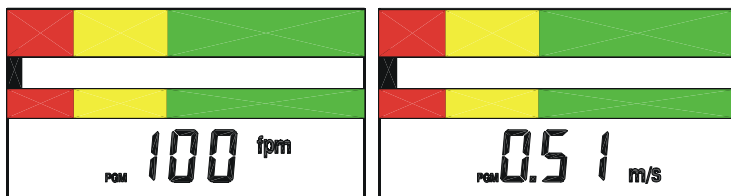

Pressing either the Up or Down Button toggles between the two settings. When the desired setting is displayed, press the Test/Reset button. The PGM descriptor will flash once and the horn will give two quick beeps to acknowledge the save. The digits and applicable unit descriptor (fpm or m/s) will either be on or off during normal run mode.

The monitor will return to the P01 Configuration menu selection. Press the Up and Down Buttons to advance to another Configuration Parameter. Press and hold the Test/Reset button for 2 seconds to exit the Configuration menu.

P02 — Unit of Measure

The velocity can be displayed either in feet per minute (fpm) or in meters per second (m/s), with the applicable descriptor (fpm or m/s) on during normal run mode.

After this Configuration menu selection is entered, the monitor will turn on the program mode PGM descriptor and display the current unit descriptor:

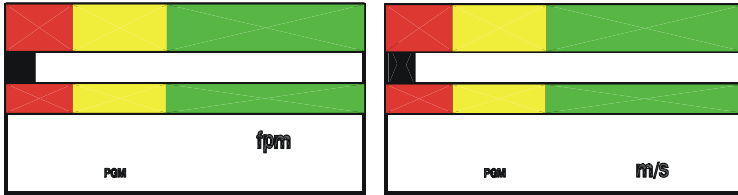

Press the Up or Down Button to toggle between the two settings. When the desired setting is displayed, press the Test/Reset button. The PGM descriptor will flash once and the horn will give two quick beeps to acknowledge the save. The applicable unit descriptor (fpm or m/s) will then be on during normal run mode.

The monitor will return to the P02 Configuration menu selection. Press the Up and Down Buttons to advance to another Configuration Parameter. Press and hold the hold the Test/Reset button for 2 seconds to exit the Configuration menu.

P03 — Temporary Horn Disable Timer

During an alarm condition, the alarm can be acknowledged by pressing the Test/Reset button. This temporarily silences the horn. Normally, the horn will be silenced for the duration of the current alarm condition. The monitor can be configured to have the horn come back on after a specified number of minutes or configured so that the horn can not be silenced at all.

This Configuration Parameter sets the temporary disable timer. After this Configuration menu selection is entered, the monitor will turn on the program mode PGM descriptor and display the current value for the temporary horn disable timer. This timer can be set to a value from 0 to 255. A setting of 255 indicates that when the alarm is temporarily silenced by pressing the Test/Reset button, the horn will not come on again until this alarm condition clears and another alarm event occurs. A setting of 0 is used to prevent silencing of the horn by pressing the Test/Reset button. Any value between indicates the time, in minutes, after which when the horn will come back on if the alarm condition has not been corrected.

For example, if the monitor is configured for a temporary horn disable time of 10 minutes, the display will show:

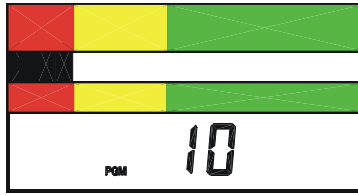

Press the Up Button to increase the timer value by 1 minute or the Down Button to decrease the timer value by 1 minute. When the desired setting is displayed, press the Test/Reset button. The PGM descriptor will flash once and the horn will give two quick beeps to acknowledge the save.

The monitor will return to the P03 Configuration menu selection. Press the Up and Down Buttons to advance to another Configuration Parameter. Press and hold the hold the Test/Reset button for 2 seconds to exit the Configuration menu.

P04 — Caution-to-Alarm Transition Delay Timer

The yellow caution to red alarm transition time is the delay period, in seconds, that a given air flow condition must remain present before the monitor will go into the appropriate alarm zone. This feature prevents the monitor from toggling back and forth between zones when a condition is on the border.

This Configuration Parameter sets the caution-to-alarm transition timer. After this configuration menu selection is entered, the monitor will turn on the program mode PGM descriptor and display the current value for the caution-to-alarm transition timer. This timer can be set from 0 to 255 seconds.

For example, if the monitor is currently configured for a caution-to-alarm transition time of three seconds, the display will show:

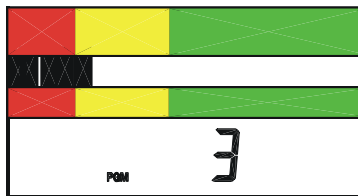

Press the Up Button to increase the timer value by 1 second or the Down Button to decrease the timer value by 1 second. When the desired setting is displayed, press the Test/Reset button. The PGM descriptor will flash once and the horn will give two quick beeps to acknowledge the save.

The monitor will return to the P04 Configuration menu selection. Press the Up and Down Buttons to advance to another Configuration Parameter. Press and hold the hold the Test/Reset button for 2 seconds to exit the Configuration menu.

P05 — Alarm-to-Caution Transition Delay Timer

The red alarm to yellow caution transition time is the delay period in seconds that an air flow condition must remain present before the monitor will go into the appropriate warning zone. This feature prevents the monitor from toggling back and forth between zones when a condition is on the border.

This Configuration Parameter sets the alarm-to-caution transition timer. After this Configuration menu selection is entered, the monitor will turn on the program mode PGM descriptor and display the current value for the alarm-to-caution transition timer. This timer can be set from 0 to 255 seconds.

For example, if the monitor is currently configured for an alarm-to-caution transition time of three seconds, the display will show:

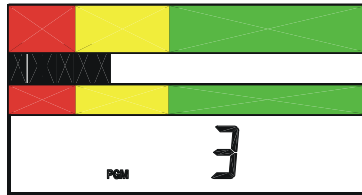

Press the Up Button to increase the timer value by 1 second or the Down Button to decrease the timer value by 1 second. When the desired setting is displayed, press the Test/Reset button. The PGM descriptor will flash once and the horn will give two quick beeps to acknowledge the save.

The monitor will return to the P05 Configuration menu selection. Press the Up and Down Buttons to advance to another Configuration Parameter. Press and hold the hold the Test/Reset button for 2 seconds to exit the Configuration menu.

P06 — Low Alarm Caution Offset

The low caution offset defines the starting point of the low caution zone. It is a value (in the current unit of measure) that is added to the low alarm set point. It determines when the yellow low caution light comes on.

EXAMPLE: *If the low alarm is set at 70 fpm and the low alarm caution offset is set at 20 fpm, the yellow low caution light will come on at a value of 70 to 89 fpm.*

This Configuration Parameter sets the low alarm caution offset. After this configuration menu selection is entered, the monitor will turn on the program mode PGM descriptor and display the current value for the low alarm caution offset.

For example, if the monitor is currently configured for a low alarm caution offset of 20 fpm, the display will show:

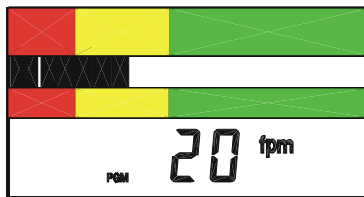

Press the Up Button to increase the value by 1 measurement unit or the Down Button to decrease the value by 1 measurement unit. When the desired setting is displayed, press the Test/Reset button. The PGM descriptor will flash once and the horn will give two quick beeps to acknowledge the save.

The monitor will return to the P06 Configuration menu selection. Press the Up and Down Buttons to advance to another Configuration Parameter. Press and hold the hold the Test/Reset button for 2 seconds to exit the Configuration menu.

P07 — Dis Input

This Configuration Parameter configures the switch settings for the instrument's Remote Test/Reset, Remote Emergency Purge, and Night Setback features. After this Configuration menu selection is entered, the monitor will turn on the Program mode PGM descriptor and display the current setting. Press the Up and Down arrow keys to scroll through the available settings.

NOTE: P07 may only be configured to have one of these features operational at a time. The Remote Test/Reset and Remote Emergency Purge functions are also available under P08.

Remote Test/Reset — This allows the operator to activate the instrument's Test/Reset function remotely via a contact closure. It functions in the same manner as the Test/Reset button on the instrument's front panel (see Section 1). The local Test/Reset button is still active even if the instrument is configured for Remote Test/Reset. If this function is active, the following display will appear under P07:



Remote Emergency Purge — This allows the operator to activate the instrument's Emergency Purge function remotely via a contact closure. It functions in the same manner as the Emergency Purge button on the instrument's front panel (see Section 1). The local Emergency Purge button is still active even if the instrument is configured for Remote Emergency Purge. If this function is active, the following display will appear under P07:



Night Setback — Night setback can be configured for either a contact closure or opening. If the monitor is configured to go into the night setback mode when the contacts are closed, the display will show:



If the monitor is configured to go into night setback when the contacts are opened, the display will show:



When activated, the night setback performs one of two possible actions, based on the setting of P12.

P12 = OFF — The monitor is disabled when in the Night Setback mode. The horn is off, the relays are in their “normal” state, and all the LEDs are off. The LCD flashes “diS” once per second.

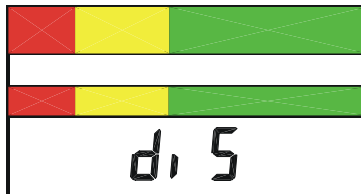

P12 = a Number — This number is the low alarm setpoint value when the monitor is in the Night Setback mode; this value overrides the normal low alarm setting. The caution range during Night Setback is automatically extended from the normal warning alarm point to the P12 setting. Normal flow is any flow reading that is above the normal warning alarm limit. Night Setback also alters the low alarm setting feature. Pressing the Down button while in Night Setback Low Alarm mode displays the night setback low alarm setting; holding the Down button down for five seconds allows you to change the night setback

low alarm setting, but does not allow you to turn it off. See P12 for information on turning the night setback low alarm off.

When the desired setting (Remote Test/Reset, Remote Emergency Purge, or Night Setback) is displayed, press the Test/Reset button. The PGM descriptor will flash once and the horn will emit two quick beeps to acknowledge that the setting has been saved.

The monitor will return to the P07 Configuration menu selection. Press the Up and Down Buttons to advance to another Configuration Parameter. Press and hold the hold the Test/Reset button for 2 seconds to exit the Configuration menu.

P08 — Alarm Input

This Configuration Parameter configures the switch settings for the instrument's Remote Test/Reset, Remote Emergency Purge, and Sash Override/Alarm Input features. After this Configuration menu selection is entered, the monitor will turn on the Program mode PGM descriptor and display the current setting. Press the Up and Down arrow keys to scroll through the available settings.

NOTE: P08 may only be configured to have one of these features operational at a time. The Remote Test/Reset and Remote Emergency Purge functions are also available under P07.

Remote Test/Reset — This allows the operator to activate the instrument's Test/Reset function remotely via a contact closure. It functions in the same manner as the Test/Reset button on the instrument's front panel (see Section 1). The local Test/Reset button is still active even if the instrument is configured for Remote Test/Reset. If this function is active, the following display will appear under P08:

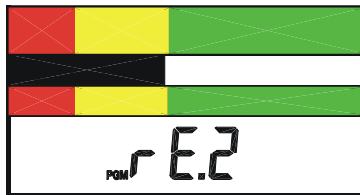

Remote Emergency Purge — This allows the operator to activate the instrument's Emergency Purge function remotely via a contact closure. It functions in the same manner as the Emergency Purge button on the instrument's front panel (see Section 1). The local Emergency Purge button is still active even if the instrument is configured for Remote Emergency Purge. If this function is active, the following display will appear under P08:



Sash Override/External Alarm Input — A selection can be made between a sash override input and external alarm input. The differences between the inputs relates to the visual, audible, and remote indications activated when the input is received by the monitor.

The sash override input can be connected to a sash position switch on the fume hood to indicate that the sash has exceeded a given height and a full alarm is sounded. When activated, the sash override puts the monitor into alarm in the same manner as a low air flow condition. The red LED lights, the horn sounds, the alarm relay is activated, and the Override descriptor on the display illuminates.

The external alarm input is typically used for some external remote event that may not warrant an alarm to the user, but is used rather as an alert of a situation that may necessitate attention. When activated, the external alarm input causes the horn on the monitor to sound intermittently and illuminates the EXT descriptor on the display to indicate that this is an external alarm. The EXT descriptor will remain on until the external alarm input returns to an inactive state. Note that this selection will *not* cause the alarm relay to activate.

NOTE: *The local alarm (steady horn) will always take precedence over an external alarm event.*

This Configuration Parameter selects the input and configures it for open or closed contacts. Open indicates that opening the contacts activates this alarm; closed indicates that closing the contacts activates the alarm.

If the monitor is configured for closed contacts to activate the external alarm, the display will show:



If the monitor is configured for open contacts to activate the external alarm, the display will show:

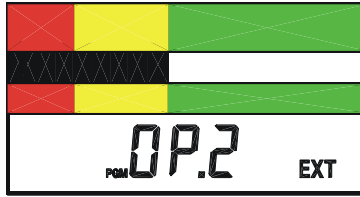

If the monitor is configured for closed contacts to activate the sash override alarm, the display will show:

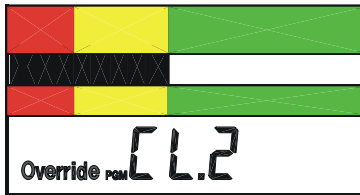

If the monitor is configured for open contacts to activate the sash override alarm, the display will show:



Press either the Up or Down button to scroll through the settings. When the desired setting is displayed, press the Test/Reset button. The PGM descriptor will flash once and the horn will give two quick beeps to acknowledge the save.

The monitor will return to the P08 Configuration menu selection. Press the Up and Down Buttons to advance to another Configuration Parameter. Press and hold the hold the Test/Reset button for 2 seconds to exit the Configuration menu.

P09 — Relay Output 1

This relay output has contacts that are open in the non-energized state. The contacts can be configured to close when the function is activated or to open when the function is activated or power is lost. It may also be deactivated. The table below describes the selections:

Relay Function	Setting Displayed	Contact State
Not Used	--.1	Always open
Alarm Output	CL.1 with horn icon and red LED	Closed when in alarm
Alarm Output	OP.1 with horn icon and red LED	Open when in alarm or when power is lost
Caution Output	CL.1 with horn icon and yellow LED	Closed when in caution or alarm
Caution Output	OP.1 with horn icon and yellow LED	Open when in caution, alarm, or when power is lost
Emergency Purge Output	CL.1 with EMERG	Closed when in emergency purge
Emergency Purge Output	OP.1 with EMERG	Open when in emergency purge or power is lost

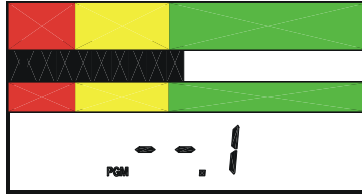

The relay function is disabled when the display shown above is selected. The relay function is enabled when one of the following displays is selected.



NOTE: *The red LED at the top of the instrument will light in conjunction with two displays shown above when the Alarm Output selections appear; the yellow LED will light when the Caution Output selections appear.*



Press either the Up or Down button to cycle through the settings. When the desired setting is displayed, press the Test/Reset button. The PGM descriptor will flash once and the horn will give two quick beeps to acknowledge the save.

The monitor will return to the P09 Configuration menu selection. Press the Up and Down Buttons to advance to another Configuration Parameter. Press and hold the hold the Test/Reset button for 2 seconds to exit the Configuration menu.

P10 — Relay Output 2

This relay output has contacts that are closed in the non-energized state. The contacts can be configured to open when the function is activated or to close when the function is activated or power is lost. The table below describes the selections:

Relay Function	Setting Displayed	Contact State
Not Used	--.2	Always closed
Alarm Output	CL.2 with horn icon and red LED	Closed when in alarm or power is lost
Alarm Output	OP.2 with horn icon and red LED	Open when in alarm
Caution Output	CL.2 with horn icon and yellow LED	Closed when in caution, alarm, or when power is lost
Caution Output	OP.2 with horn icon and yellow LED	Open when in caution or alarm
Emergency Purge Output	CL.2 with EMERG	Closed when in emergency purge or when power is lost
Emergency Purge Output	OP.2 with EMERG	Open when in emergency purge

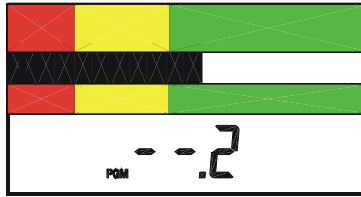

The relay function is disabled when the display shown above is selected. The relay function is enabled when one of the following displays is selected.

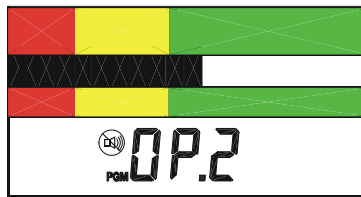
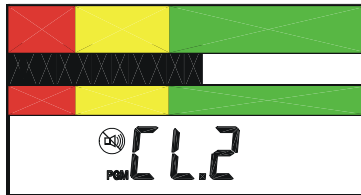

NOTE: *The red LED at the top of the instrument will light in conjunction with two displays above when the Alarm Output selections appear; the yellow LED will light when the Caution Output selections appear.*



Press either the Up or Down button to cycle through the settings. When the desired configuration is displayed, press the Test/Reset button. The PGM descriptor will flash once and the horn will give two quick beeps to acknowledge the save.

The monitor will return to the P10 Configuration menu selection. Press the Up and Down Buttons to advance to another Configuration Parameter. Press and hold the hold the Test/Reset button for 2 seconds to exit the Configuration menu.

P11 — High Alarm Relay Disable

The alarm state can be sent to a remote location by means of a relay output. The relay can be disabled for the high alarm if it is not warranted for the application.

This Configuration Parameter disables or enables the high alarm relay output. After this Configuration menu selection is entered, the monitor will turn on the program mode PGM descriptor and display the current value for the high alarm relay activation.

If the monitor is configured for the relay to be enabled for the high alarm, the display will show:

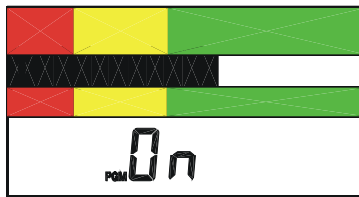

If the monitor is configured for the relay to be disabled for the high alarm, the display will show:

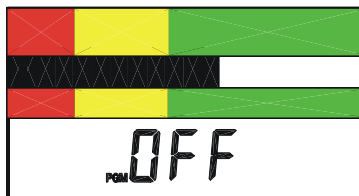

Press either the Up or Down button to alternate between the two settings. When the desired configuration is displayed, press the Test/Reset button. The PGM descriptor will flash once and the horn will give two quick beeps to acknowledge the save.

The monitor will return to the P11 Configuration menu selection. Press the Up and Down Buttons to advance to another Configuration

Parameter. Press and hold the hold the Test/Reset button for 2 seconds to exit the Configuration menu.

P12 — Night Setback Low Alarm

This Configuration Parameter sets the night setback low alarm. After this configuration menu selection is entered, the monitor will turn on the program mode PGM descriptor and display the current value for the night setback low alarm. It may be set to “OFF” or a numerical value; see P07 for a functional description of this feature.

If the monitor is configured for a night setback low alarm of 55 fpm, for example, the display will show:

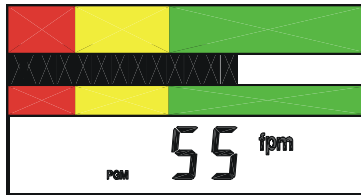

Press the Up/Down buttons to increase/decrease the displayed value by 1 measurement unit. Once the displayed value reaches a setting where it is above the normal low alarm or below the lowest setpoint of the instrument, the display will go to OFF.

When the desired setting is displayed, press the Test/Reset button. The PGM descriptor will flash once and the horn will emit two quick beeps to acknowledge the save.

dEF — Reset Configuration Parameters to Factory Default Settings

PO1 – PO11 can be reset to the factory defaults located in the memory of the fume hood monitor. This does not reset the field calibration or the low and high alarm settings. After this configuration menu selection is entered, the monitor will turn on the program mode PGM descriptor and the display will show:

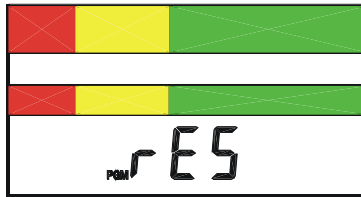

Press the Test/Reset button. The PGM descriptor will be continuously displayed and the horn will give two quick beeps to acknowledge that the configuration settings have been set to their factory default settings.

The monitor will return to the dEF Configuration menu selection. Press the Up and Down Buttons to advance to another Configuration Parameter. Press and hold the hold the Test/Reset button for 2 seconds to exit the Configuration menu.

SECTION 6

Troubleshooting and Service

Error Codes

NOTE: *Error codes associated with Calibration (ErL, ErH, Err, and Er2 do not affect normal operation. See Section 2: Installation for more information on Calibration Error Codes.*

Error checks are continuously performed on the monitor. In the event the monitor detects an error, an error message will continuously flash on the display to alert the user. The number in the error code relates to the specific error found. This error message cannot be cleared; the monitor needs to be returned to the factory for service. Please contact TSI for assistance.

NOTE: *To prevent erroneous readings, the monitor will lock up.*

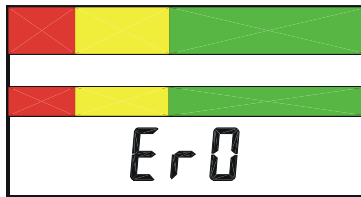

Troubleshooting Guide

Problem	Possible Cause / Corrective Action
No display or lights.	The power supply cord is not plugged into the monitor or live AC outlet.
No audible alarm when display shows Lo or Hi.	Audible alarm disabled. If horn slash through icon is flashing, the horn has been permanently disabled. Press Test/Reset button for 5 seconds to re-enable.
No audible alarm only when display shows Hi.	High alarm disabled. See “Changing Alarm Set Points” section to enable.
Pulsed audible alarm.	This indicates an external alarm. The EXT descriptor on the LCD should also be on. Attend to the external alarm event. See Configuration Parameter P08.
Nothing happens when the Emergency Purge button is pressed.	The emergency purge function is not configured. See Configuration Parameters P09 and P10.
Alarm does not activate immediately. Alarm does not come out of alarm immediately when good air flow is restored.	The alarm or clear condition must exist for a predetermined time period before it is interpreted as a true event. See Configuration Parameters P04 and P05 to set the transition delays.
Monitor does not display the expected air flows.	<p>The blower speed has changed. Use a thermo-anemometer to perform a traverse to check the true face velocity;</p> <p>The flexible air hose from the monitor to the side wall sensing hole may be kinked or bent, restricting the true air flow. Reroute the hose and recheck the connections at each end;</p> <p>If the calibration of the monitor is suspect, recalibrate as outlined in Section 3.</p>

Problem	Possible Cause / Corrective Action
Audible alarm cannot be temporarily silenced using the Test/Reset button.	The temporary disable timer is set to 0. See Configuration Parameter 03 to set the temporary disable timer.
Monitor is flashing "diS."	The monitor is in night set back mode and is disabled. See Configuration Parameter P07.
Monitor keeps bouncing back and forth between adjacent zones.	The monitor is being influenced by an external air source. Remove the source of drafts. See Configuration Parameters P04 and P05 to set the transition delays.

Service Requests

If you need assistance, please contact TSI.

Ship to:

TSI Incorporated
 Alnor Products
 500 Cardigan Road
 Shoreview, MN 55126 USA
 Toll-Free (800) 424-7427
 Telephone (651) 490-2811
 Fax (651) 490-3824
 Email: customerservice@Alnor.com
www.alnor.com

SECTION 7

Mounting Template

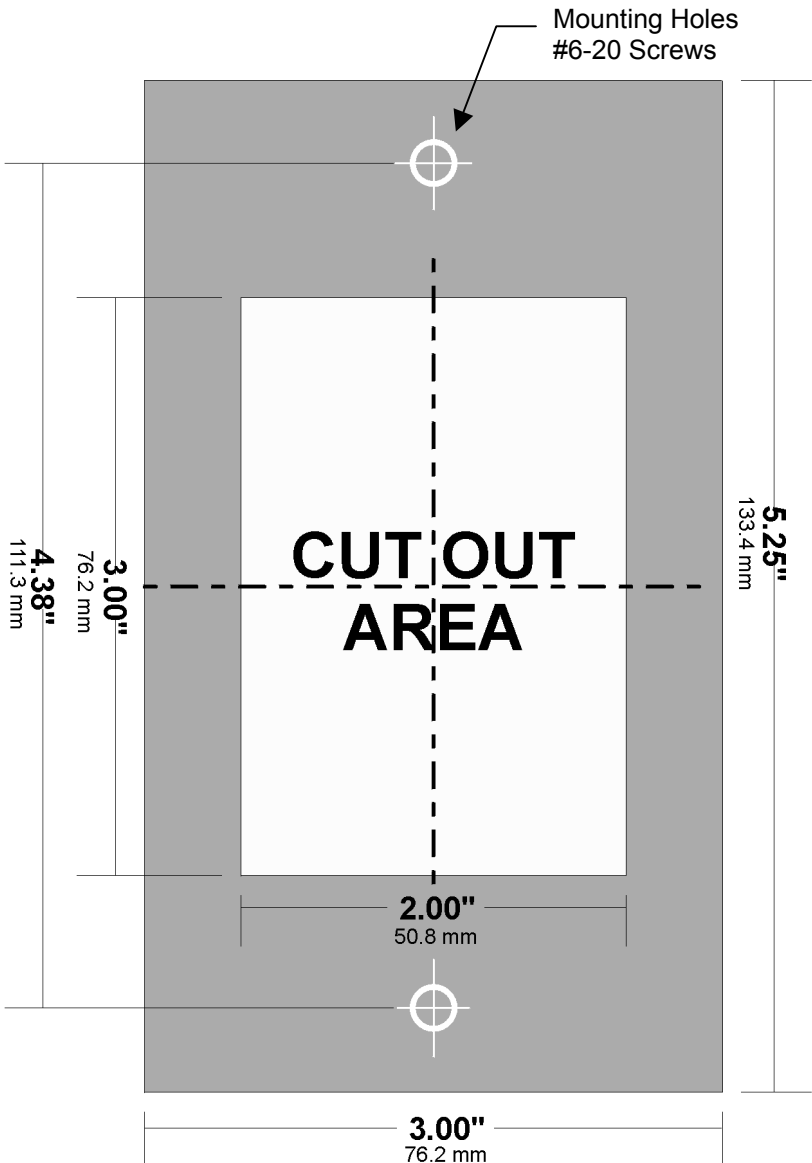

AIRGARD® 335 MONITOR SPECIFICATIONS

Digital Display	3 digit, 7 segment LCD with status indicators and icons. Electronic bargraph moves through colored zones as the velocity changes.
Display Units	If digits are enabled, velocity is represented in feet per minute (fpm) or meters per second (m/s). User selectable through menu.
Display Range	50 to 250 fpm (0.25 to 1.27 m/s). Over range measurements shown as Hi. Under range measurements show as Lo.
Resolution	1 fpm or 0.01 m/s.
Accuracy	±10% or 10 fpm, whichever is greater.
Alarm Range	50 to 250 fpm (0.25 to 1.27 m/s).
Alarm Delays	User configurable from 0 to 255 seconds.
Audible Alarm Indication	85 dB at 4 inches (10 cm).
Horn Silence	Temporary and permanent.
Night Set Back	Monitor can be remotely disabled.
Visual Alarm Indication	Large red LED for low flow and high flow alarm zones.
Visual Caution Indication	Large yellow LED for low flow caution zones. Caution offset is configurable through menu.
Visual Normal Indication	Large green LED for normal flow zone.
High Flow Alarm Disable	Audible, visual, and relay disable.
Alarm Relay Output	Nominal switching capacity 1A at 30 VDC, 0.5A at 125 VAC; form A relay.
Emergency Purge	Button on front of monitor activates a relay that can be used to command the fume hood damper to open fully until pressed again. Nominal switching capacity 1A at 30 VDC, 0.5A at 125 VAC, form A relay.
External Alarm Input	Intermittent audible and LCD status indicate external alarm.
Sash Override Alarm Input	Audible and LCD status indicators indicate the sash position switch has been tripped.
Calibration	Two point field calibration required.
Instrument Dimensions	<u>Front Faceplate</u> — 5.25 (L) x 3.0 (W) x 5/8 (D) inches (13.3 x 7.6 x 1.6 cm); <u>Rear Enclosure</u> — 3.0 (L) x 2.0 (W) x 0.5 (D) inches (7.6 x 5.0 x 1.3 cm).
Mounting	Flush, 3.0 (L) x 2.0 (W) inch (7.6 x 5.1 cm) cutout required on hood surface.
Operating Conditions	55° to 86°F (13° to 30°C), 5% to 95% RH, non-condensing.
Storage Temperature	-40° to 150°F (-40° to 65°C), 5% to 95% RH, non-condensing.
Power Requirement	9 to 30 V AC/DC. Wall plug in power supply supplied for US and Canada.

The calibration and configurable parameters are stored in the non-volatile memory of the instrument and are not lost when the monitor loses power.



TSI Incorporated
Alnor Products
500 Cardigan Road
Shoreview, MN 55126 USA
Toll-Free (800) 424-7427
Telephone (651) 490-2811
Fax (651) 490-3824
Email: customerservice@Alnor.com
www.alnor.com

February 2003
Printed in USA
Patent #4,982,605
Part No. 116-159-255 Rev. 5
© Copyright 2003 TSI Incorporated